

# 3D SMART SENSORS FOR INLINE INSPECTION



Gocator 2410



Gocator 3210

Two trusted 3D technologies for inline metrology-grade inspection.

## LASER PROFILERS

Gocator Point and Line Profile Sensors inspect any **moving target** with height resolutions down to  $1.1\ \mu\text{m}$ , sampling speeds up to 32 kHz, and a suite of built-in 3D measurement tools and smart features to deliver a complete 3D inspection solution.





## SNAPSHOT SENSORS

Gocator Stereo Snapshot Sensors generate 3D point clouds with a single scan trigger. These sensors offer built-in 3D measurement tools to inspect **any stationary target**, or automate assembly using robot guidance.

# WELCOME TO **FACTORYSMART**<sup>®</sup> INSPECTION

## **Gocator**<sup>®</sup>

Gocator 3D smart sensors connect seamlessly with factory infrastructure to report measurement results, monitor trends from a web browser, upgrade sensors over the Internet, or network with other machinery to exchange or combine data.

### Easy to Use

Features such as a web-browser driven point-and-click environment for rapid configuration, built-in measurement tools and rich I/O for communicating results make it easy for factory technicians to get the results they need.

### Low Latency with No External Controller Required

Real-time measurement capabilities minimize lag between data acquisition and decision outputs, which means factories can consistently meet their throughput targets.

### Built-In Measurement Tools

Built-in tools provide a drag and drop environment with full 3D visualization, and allow users to set measurements based on the specific feature that needs to be inspected.

### Customizable

Sensor customization allows users to develop and embed their own custom measurement tools directly into the firmware itself—with the same functionality and ease-of-use as built-in native tools.

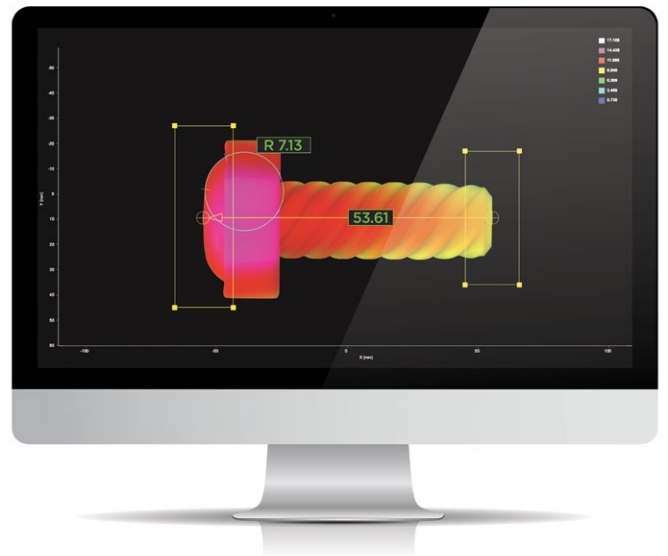

## **3D IS OUR EXPERTISE**

At LMI Technologies we work to advance quality and productivity with 3D sensor technology. Our award-winning, FactorySmart<sup>®</sup> sensors improve inline factory production by providing fast, accurate, reliable inspection solutions that leverage smart 3D technologies. Unlike contact-based measurement or 2D vision, our products remove complexity and dramatically reduce implementation cost while achieving repeatable, high-precision measurement.

# TOTAL QUALITY CONTROL WITH SMART 3D

Gocator is used in all major inline factory automation processes to achieve 100% quality control.

## PART MANUFACTURING

Most parts from processes such as casting, machining, and injection molding are never inspected. Gocator provides 100% inline quality control to ensure every part meets key manufacturing tolerances.

## COMPONENT ASSEMBLY

As parts come together to build product assemblies, how each part fits with another determines overall assembly quality. Gocator verifies proper adhesion, fastening, surface gap & flush and more.

## FINISH AND PACKAGING

Finish and sealing is critical to product acceptance. Gocator ensures finished products meet strict quality standards, are packaged correctly, and are ready for shipment.

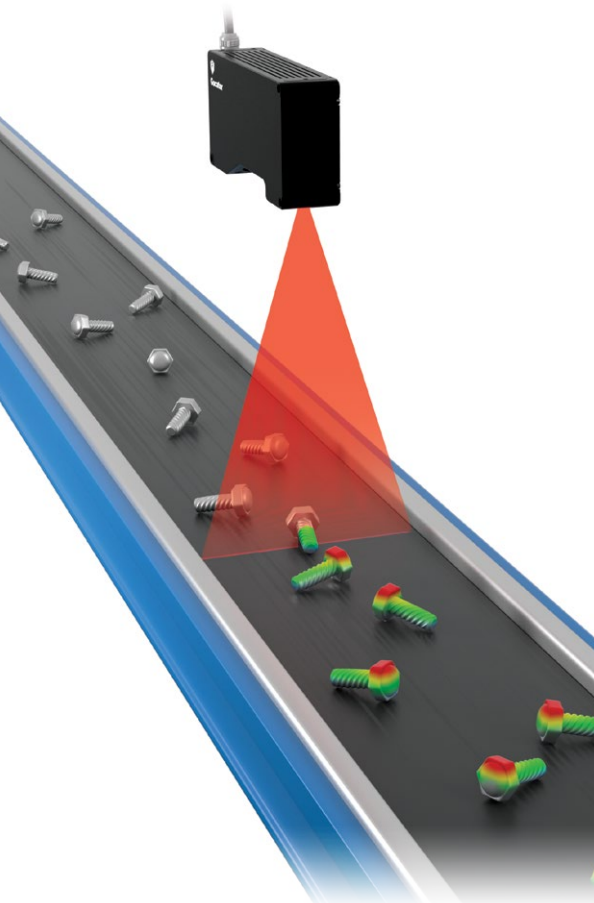

## WHY SMART 3D?

**2D vision alone cannot achieve 100% quality control, which is why you need to invest in a smart 3D solution.**

- » Volumetric measurement (X, Y, and Z-axis) provides shape and position related parameters—necessary for robot handling
- » Contrast invariant, ideal for inspecting low contrast objects
- » Immune to lighting variation and ambient light
- » Higher repeatability due to integrated optics, lighting, and pre-calibration
- » Simpler to build multi-sensor setups for large object inspection

# PART MANUFACTURING INSPECTION

## Stamping Inspection



Line profiler used to determine the final bend angle in a press brake

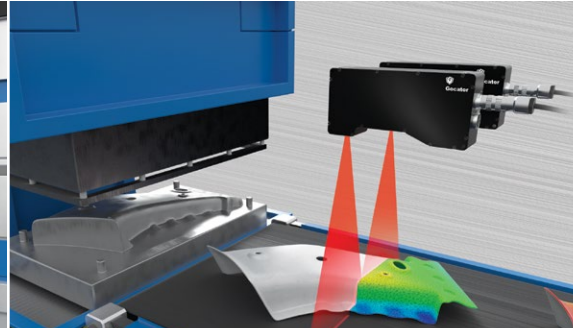

Two sensors in a wide configuration, combining profiles into a single surface scan

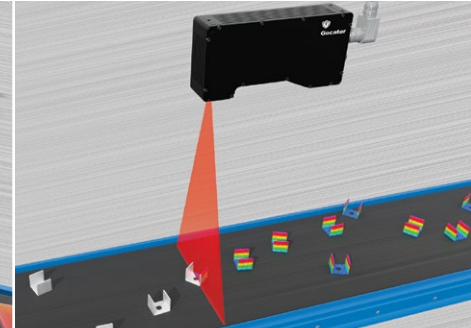

Scanning finished brackets to verify interior dimensions

## Machining Inspection

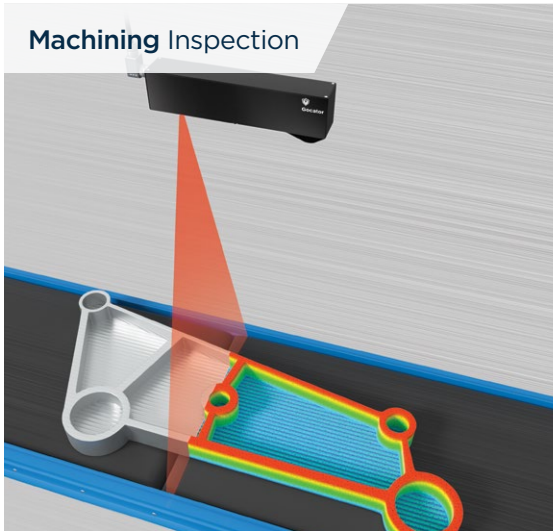

Finished CNC part scanned to verify depths and hole sizes within tolerance

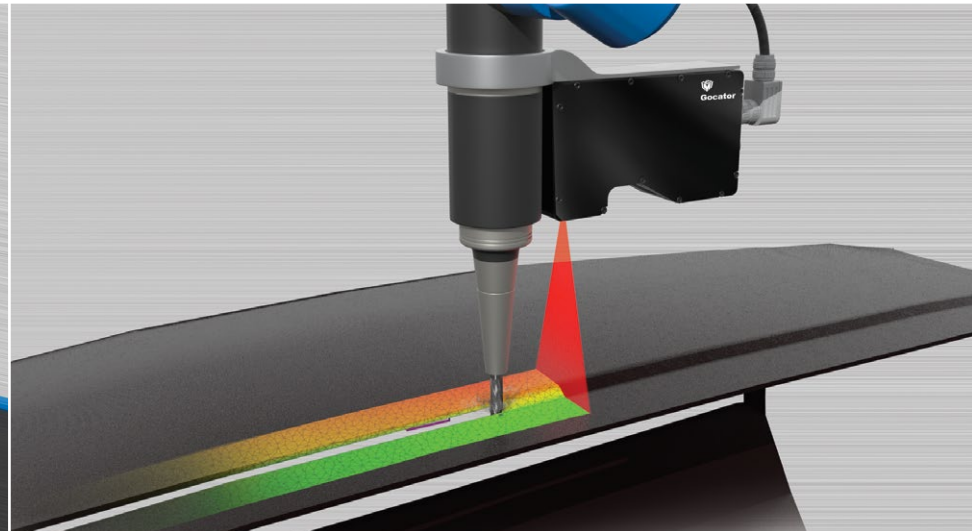

Vision-guidance for robotic CNC of an automotive dashboard



**COMMON PROBLEM:**  
**PART SHAPE AND POSITION VARIATION  
IN AN INLINE PROCESS**



**FactorySmart® SOLUTION:**  
**ACHIEVE HIGH GAUGE REPEATABILITY AND  
REPRODUCIBILITY (GRR) WITH ANCHORING AND  
PART MATCHING**

- » Built-in anchoring tracks the movement of parts within the sensor's field of view and corrects for variations in the height and position of parts.
- » Part matching automatically performs realignment before applying Gocator's built-in measurement tools—eliminating the need to mechanically realign parts.

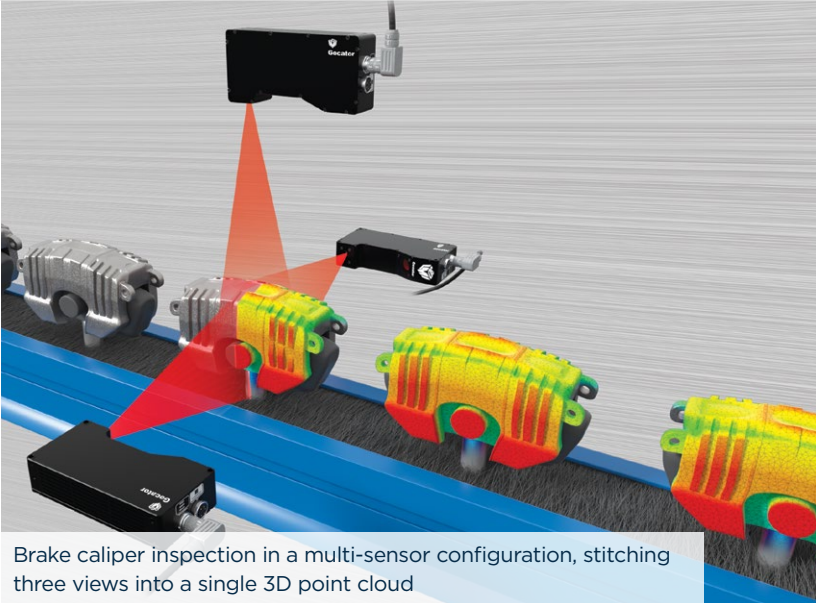
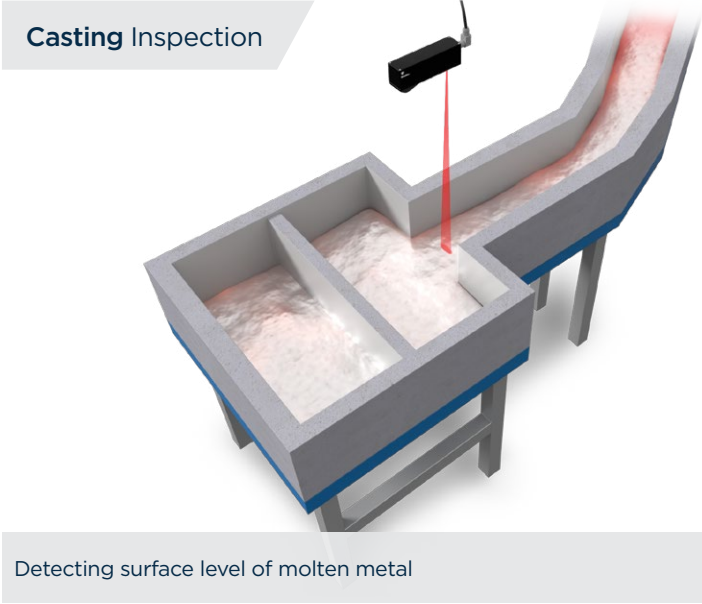
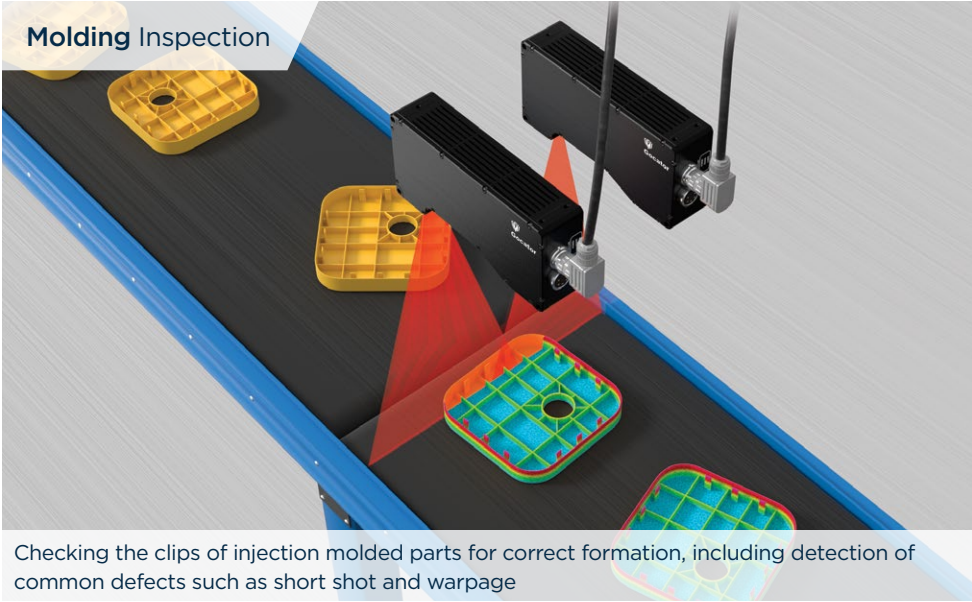

**WHY YOU NEED 3D GEOMETRY MEASUREMENT**

Unlike 2D, 3D measurement produces geometry (i.e., shape) data that is required to determine if a part meets key assembly, fit, and finish tolerances.

# PART MANUFACTURING INSPECTION

## Extrusion Inspection

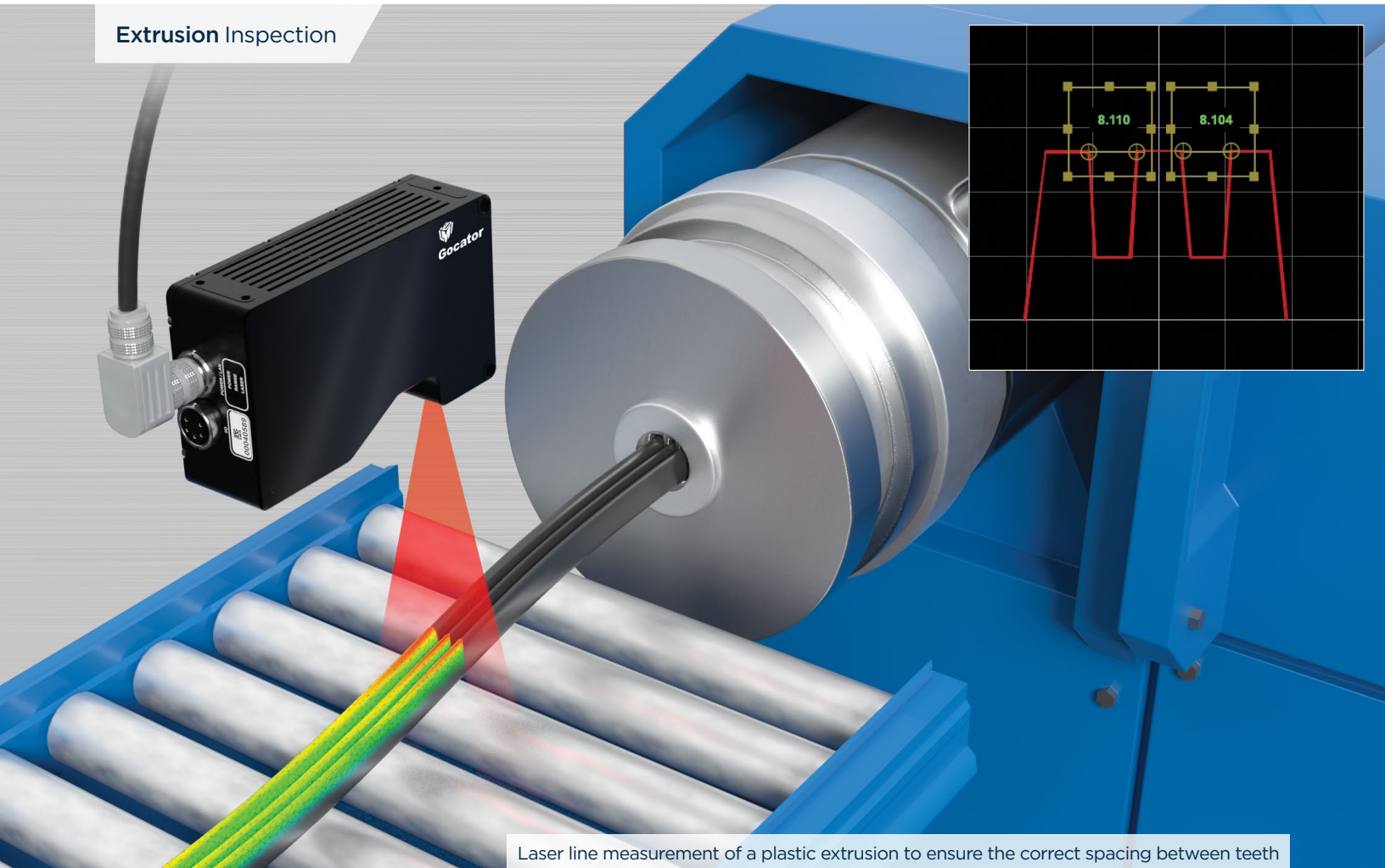

Laser line measurement of a plastic extrusion to ensure the correct spacing between teeth



**COMMON PROBLEM:**  
**COMPLEX AND TIME-CONSUMING SYSTEM SETUP**



**FactorySmart® SOLUTION:**  
**WEB-ENABLED TECHNOLOGIES AND ALL-IN-ONE DESIGN**

- » Connect to a sensor with any web browser.
- » Generate scans of your object/feature with sophisticated control over triggering, exposure, resolution, part detection, and filtering/gap filling.
- » Built-in drag and drop measurement for full geometric gauging.
- » Ethernet protocols and direct I/O are built-in and communicate pass/fail decisions directly to factory equipment (robots, PLCs, or direct I/O).



## 3D Printing Inspection

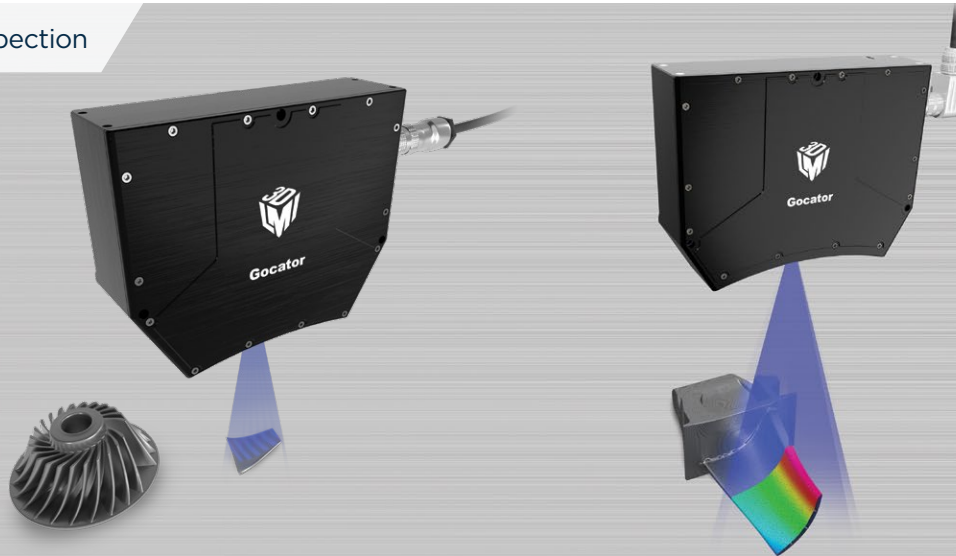

Snapshot sensor capturing surface data of a 3D printed turbine part



### SMART BENEFIT: INDUSTRIAL SENSOR DESIGN FOR HIGH MEASUREMENT RELIABILITY AND LONG PRODUCT LIFE

- » Rugged housing, small form factor, and lightweight design make Gocator sensors ideal for fitting into small spaces and mounting onto robots.
- » IP67-rated design based on industrial grade parts offers long lifetimes in continuous operation.

#### WHY YOU NEED 3D THE BENEFIT OF COMBINING 2D + 3D

Gocator laser profilers combine 3D and 2D capability for total quality inspection. In addition to 3D shape measurements, the intensity of the projected laser light is used to create a 2D image of the surface of a part. This information can be used to extract surface markings like bar codes and printed text.

# COMPONENT ASSEMBLY INSPECTION

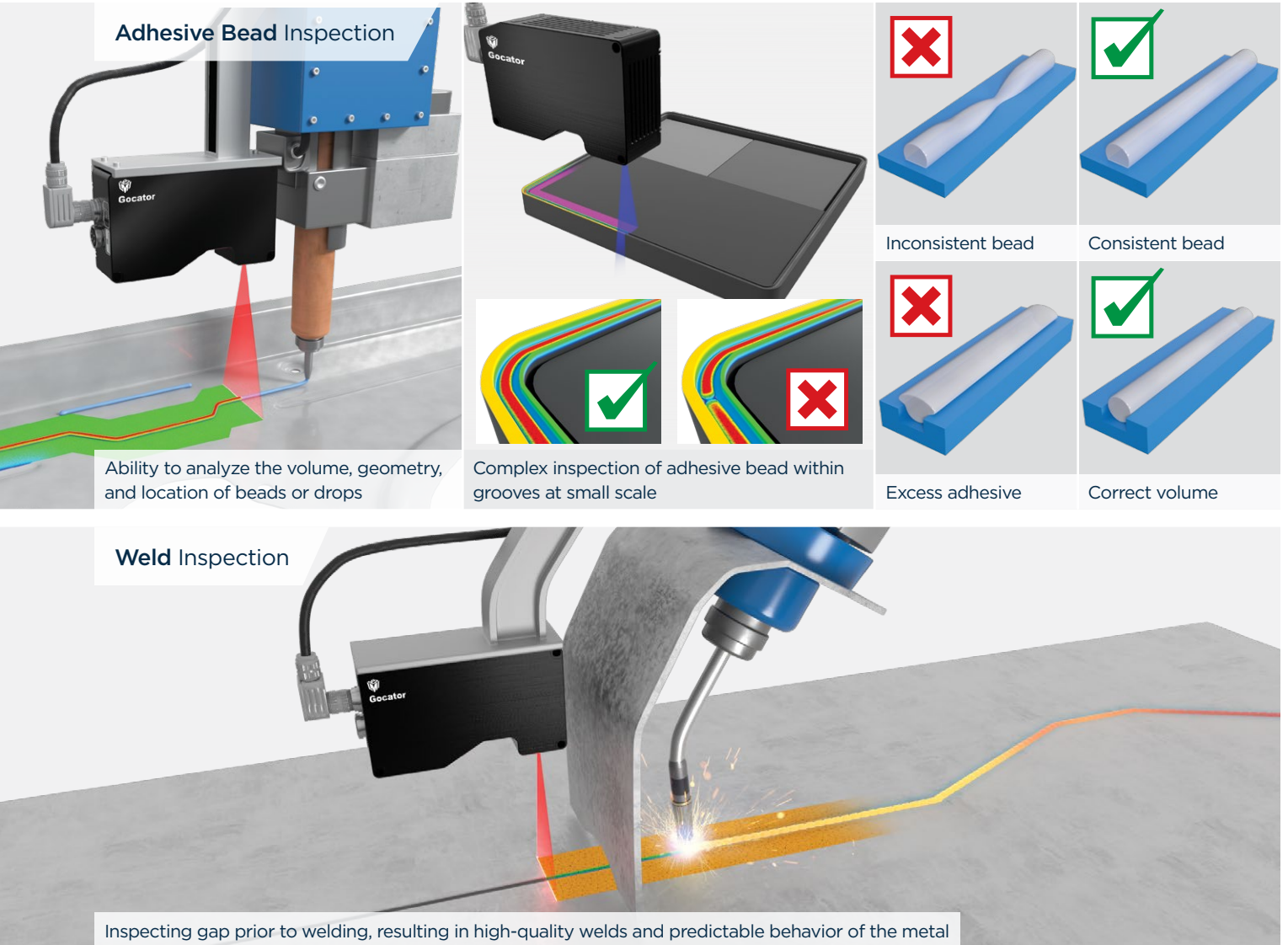

**COMMON PROBLEM:**  
**NO CUSTOM MEASUREMENT TOOLS**



**FactorySmart® SOLUTION:**  
**GOCATOR DEVELOPMENT KIT (GDK)**

- » Develop and embed your own custom measurement tools and make specialized measurements for applications with unique requirements, while protecting your IP.
- » Create optimized custom firmware builds that run within the realtime OS of the Gocator.
- » Use custom solutions on a variety of different sensors, all on a single platform.
- » Run your own measurement tools in the Gocator Emulator for offline development, testing, and support.

### Fastener Inspection

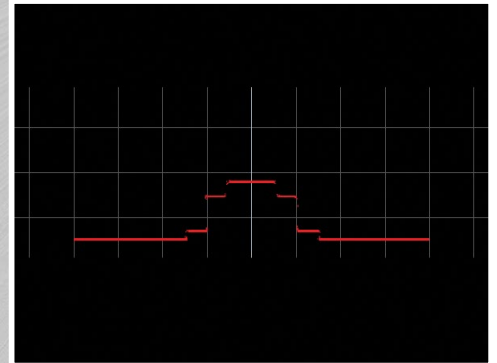
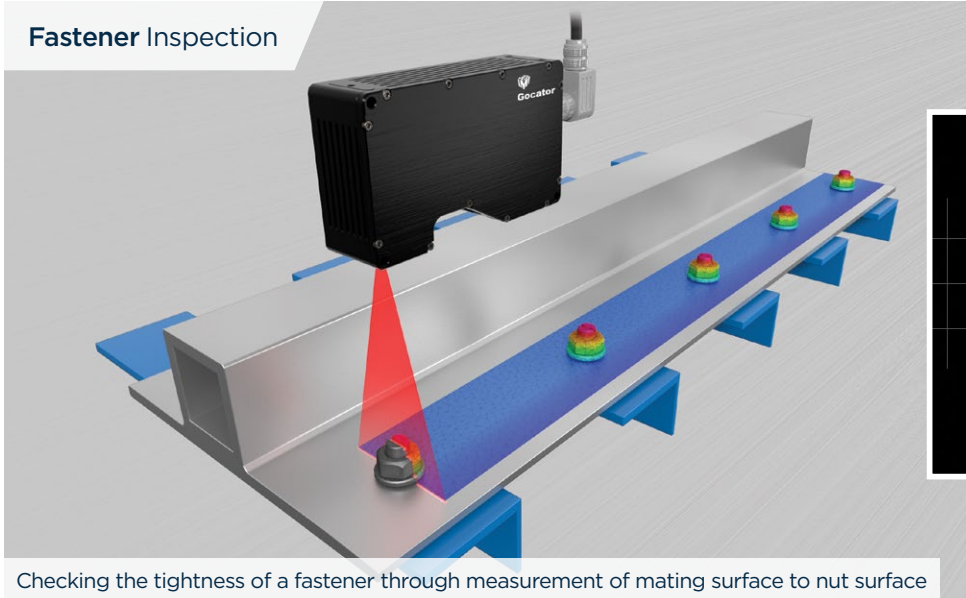

Checking the tightness of a fastener through measurement of mating surface to nut surface

### Solder Paste Inspection

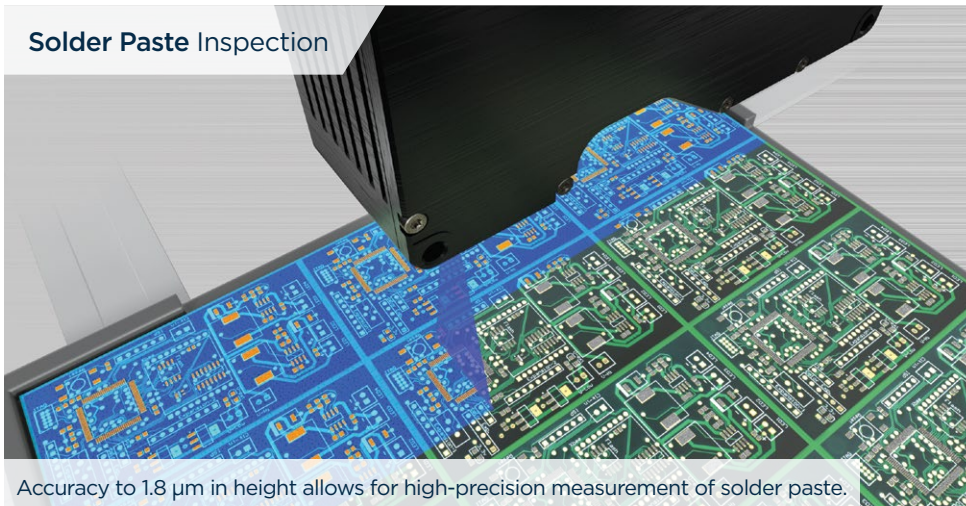

Accuracy to 1.8  $\mu\text{m}$  in height allows for high-precision measurement of solder paste.

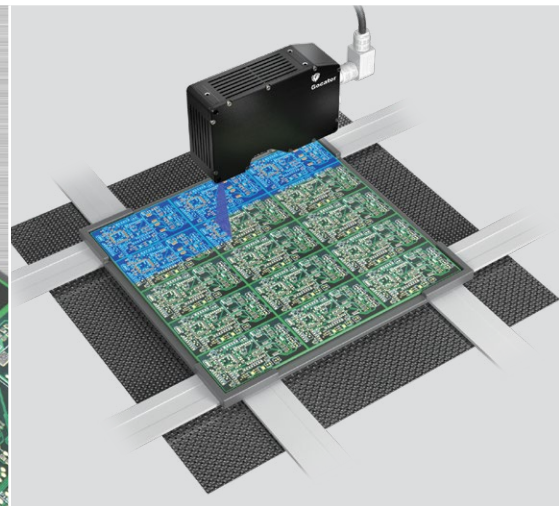

### SMART BENEFIT: HIGH-SPEED 3D PROFILING OF COMPLEX SHAPES

Laser profilers are high-speed devices that generate a line profile by combining range data from the scanned part. You can then easily perform measurements on the profile for dimensioning and inspecting complex shapes.

# COMPONENT ASSEMBLY INSPECTION

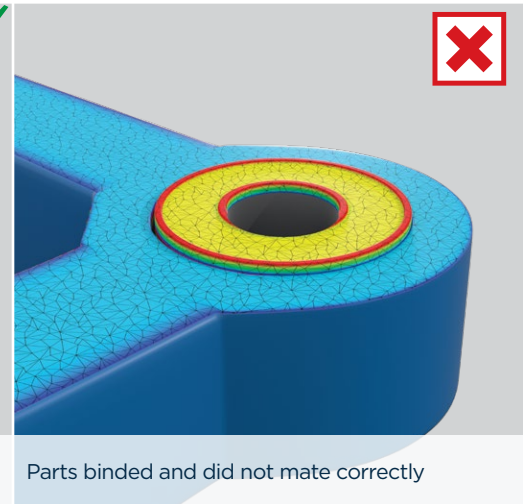
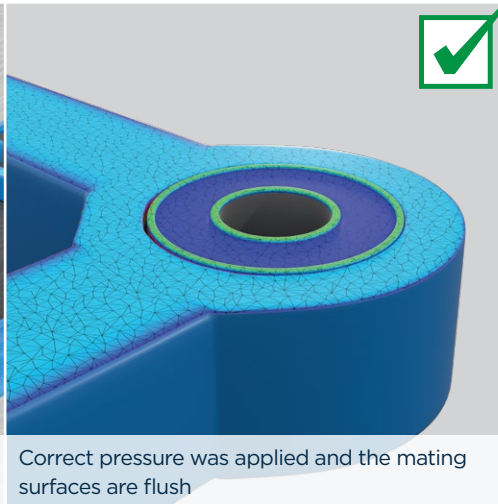
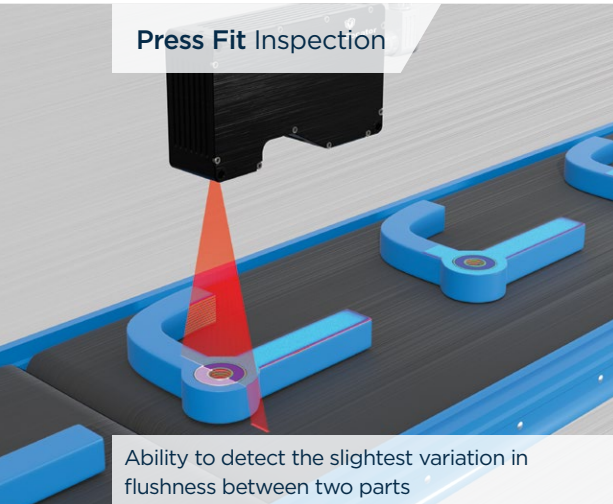
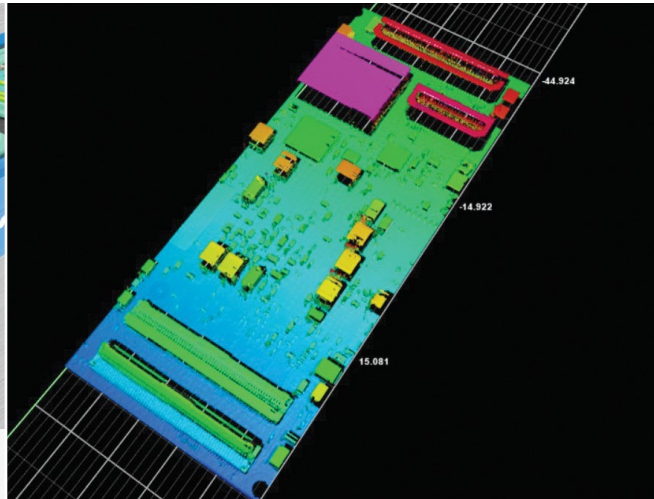
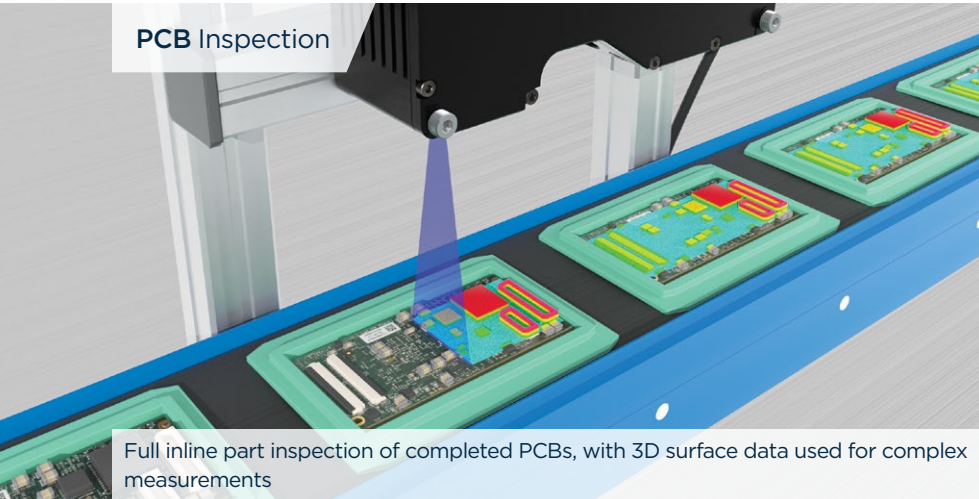

**COMMON PROBLEM:**  
**NO TIME OR RESOURCES TO CREATE AND DEPLOY YOUR OWN MEASUREMENT TOOLS**



**FactorySmart® SOLUTION:**  
**BUILT-IN MEASUREMENT TOOLS**

- » Built-in measurement tools make 3D measurement reliable, repeatable, and easy.
- » No need to send 3D point cloud data to 3<sup>rd</sup>-party software.
- » Tools include Gap & Flush, Groove, Countersunk Hole, Surface Edge, Surface Plane, and many more.

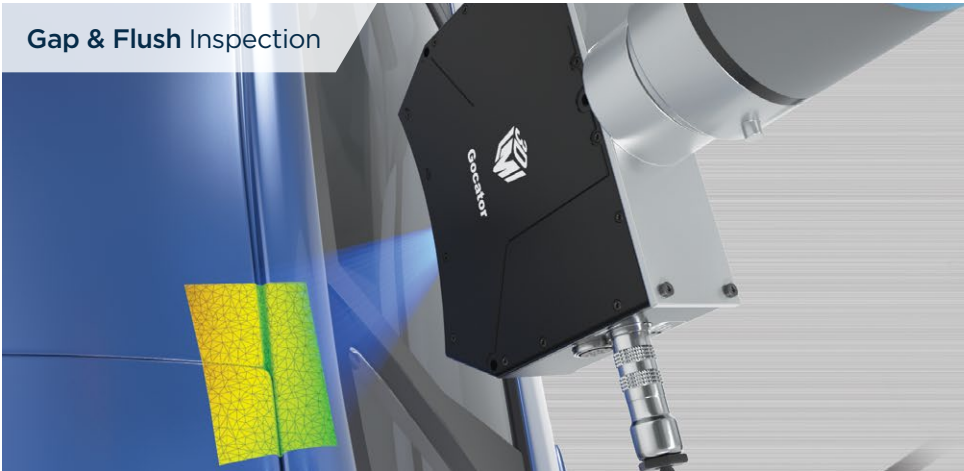

### Gap & Flush Inspection

Snapshot sensors are able to measure multiple gap & flush features within a single field of view. 3D surface data is cross-sectioned and measured for multiple profile views.

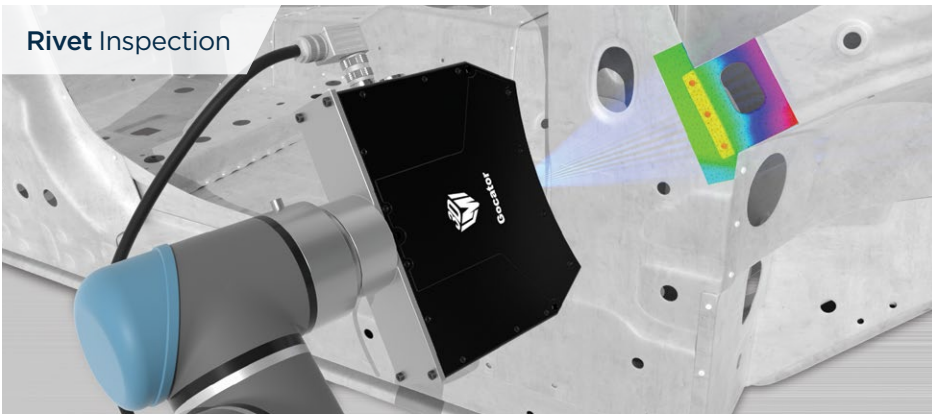
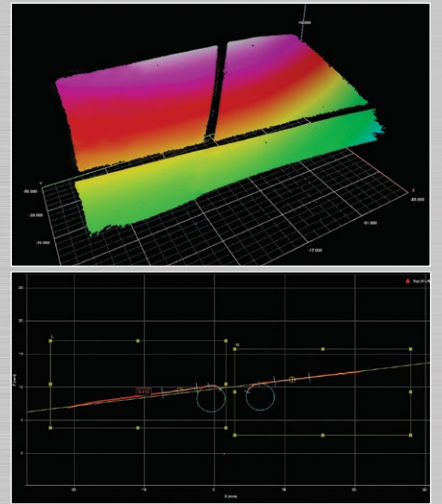

### Rivet Inspection

Robot arm mounted snapshot sensor capturing key rivet locations

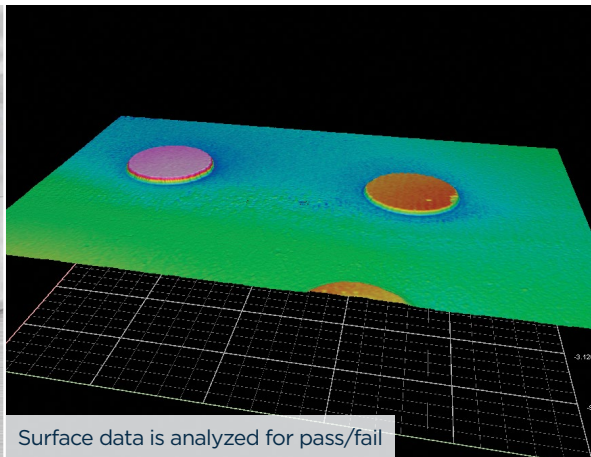

Surface data is analyzed for pass/fail



**COMMON PROBLEM:**  
**NEED VISION-GUIDANCE AND FLEXIBLE MEASUREMENT FOR ROBOTIC SYSTEMS**



**FactorySmart® SOLUTION:**  
**ROBOT-FRIENDLY HARDWARE + SOFTWARE**

- » Gocator 3D smart sensors allow a robot to sense variations in its physical environment and adapt accordingly. Gocators are the “eyes” in vision guidance and enable essential applications such as pick-and-place.
- » Gocator includes communication protocols to connect to any robot.

# PRODUCT FINISH & PACKAGING INSPECTION

## Surface Finishing Inspection

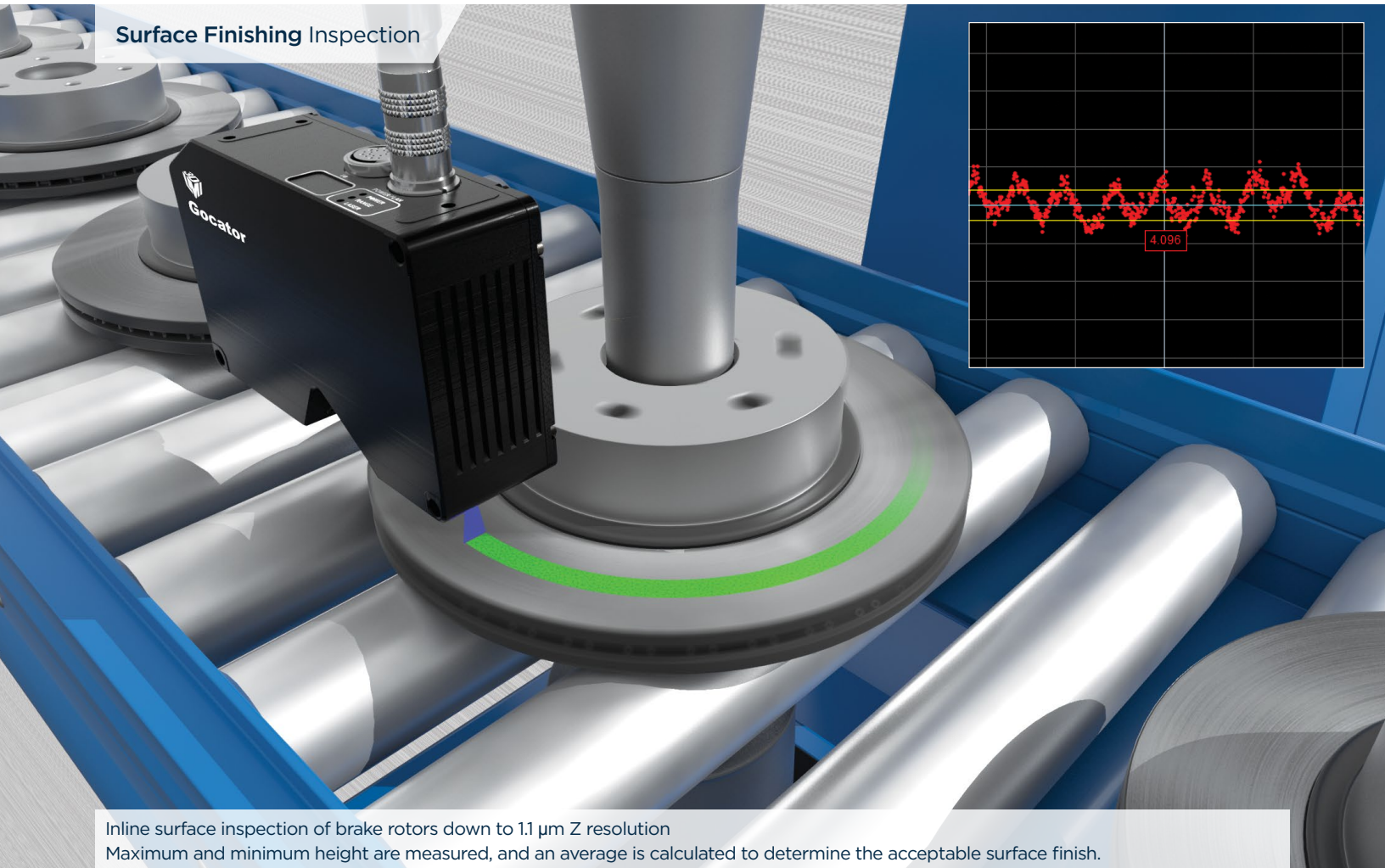

Inline surface inspection of brake rotors down to 1.1  $\mu\text{m}$  Z resolution  
Maximum and minimum height are measured, and an average is calculated to determine the acceptable surface finish.



### SMART BENEFIT: HIGH-RESOLUTION 3D SHAPE AND SURFACE ANALYSIS

Line profilers generate a high-resolution 3D height map of the target object. Built-in tools allow you to easily perform micron-level measurements of the object's geometry and surface.

#### WHY YOU NEED 3D ACCURATE SCANNING EVEN WITH OBJECT MOVEMENT

Unlike 2D, 3D provides depth measurement information that prevents errors due to object movement—meaning objects can move anywhere within the sensor's measurement range and still yield accurate results. This eliminates object fixturing requirements and improves overall system reliability.

## Sealing Inspection

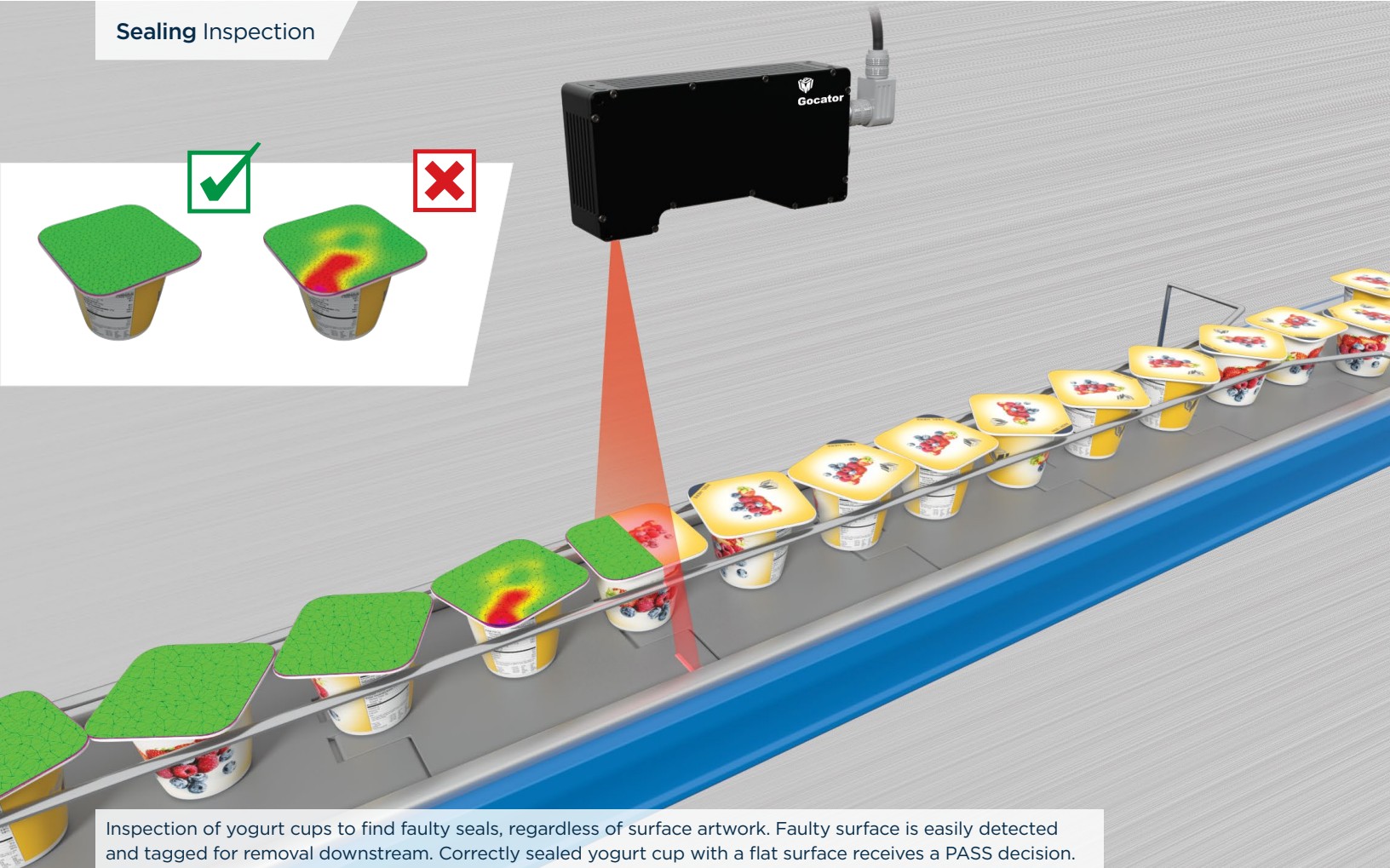

Inspection of yogurt cups to find faulty seals, regardless of surface artwork. Faulty surface is easily detected and tagged for removal downstream. Correctly sealed yogurt cup with a flat surface receives a PASS decision.



**COMMON PROBLEM:**  
**NEED TO MEET INLINE PRODUCTION SPEED**



**FactorySmart® SOLUTION:**  
**SENSOR ACCELERATION**

» Add Gocator Accelerator (GoX, a PC-based application) to share the processing load and achieve faster cycle times.

### WHY YOU NEED 3D → EASILY INSPECT LOW-CONTRAST OBJECTS

Unlike 2D intensity imaging, **3D is contrast invariant**. This means shape is measured regardless of surface color—making 3D ideal for measuring low contrast objects. In addition, with 3D you don't have to worry about ambient lighting or shadows affecting your scan results.

# PRODUCT FINISH & PACKAGING INSPECTION

## Character Identification

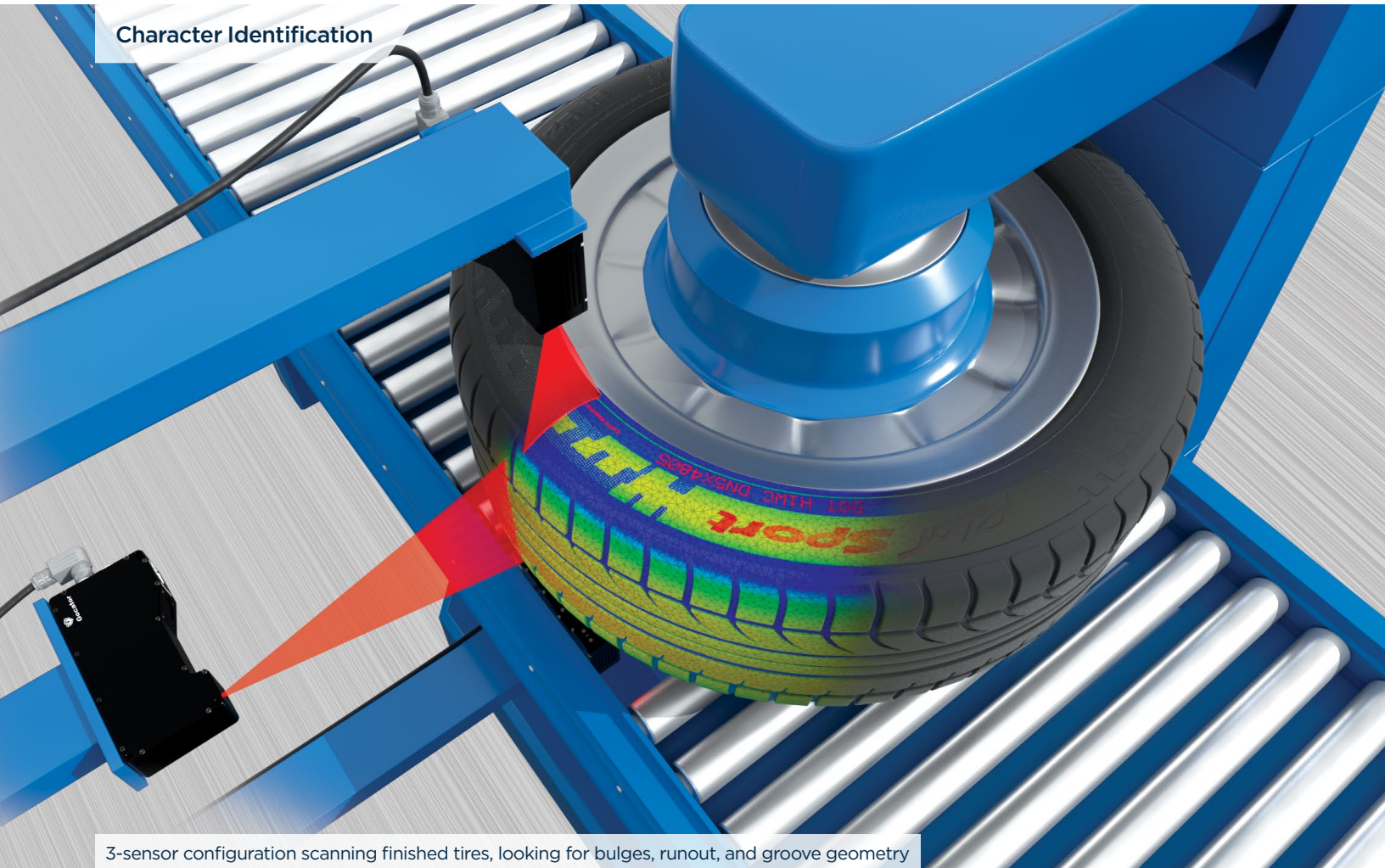

3-sensor configuration scanning finished tires, looking for bulges, runout, and groove geometry



Low-contrast unscanned surface

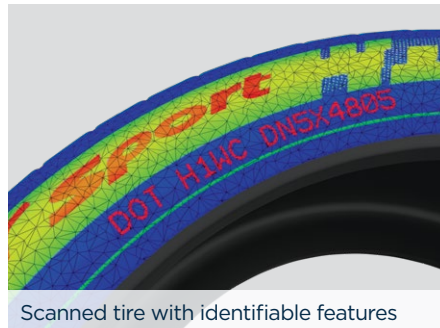

Scanned tire with identifiable features

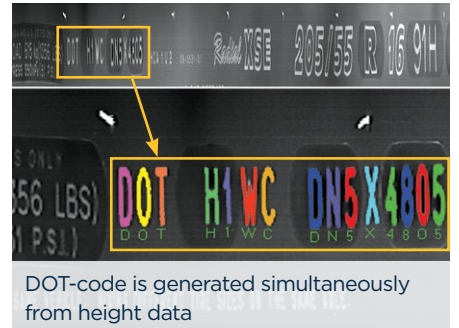

DOT-code is generated simultaneously from height data

## WHAT IS "SMART" 3D?

ALL-IN-ONE | BUILT-IN MEASUREMENT TOOLS AND SMART FEATURES | WEB BROWSER BASED GUI  
PRE-CALIBRATED | READY TO MEASURE OUT OF THE BOX



### Package Filling Inspection

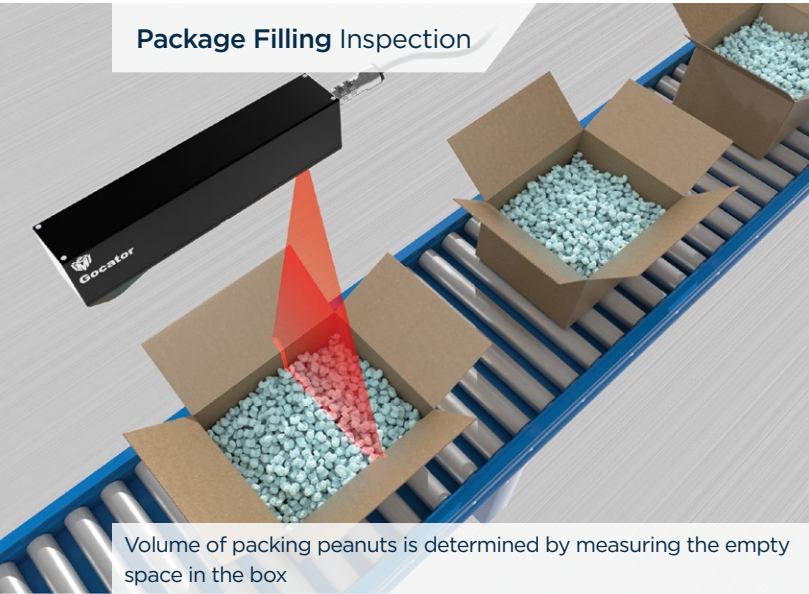

Volume of packing peanuts is determined by measuring the empty space in the box

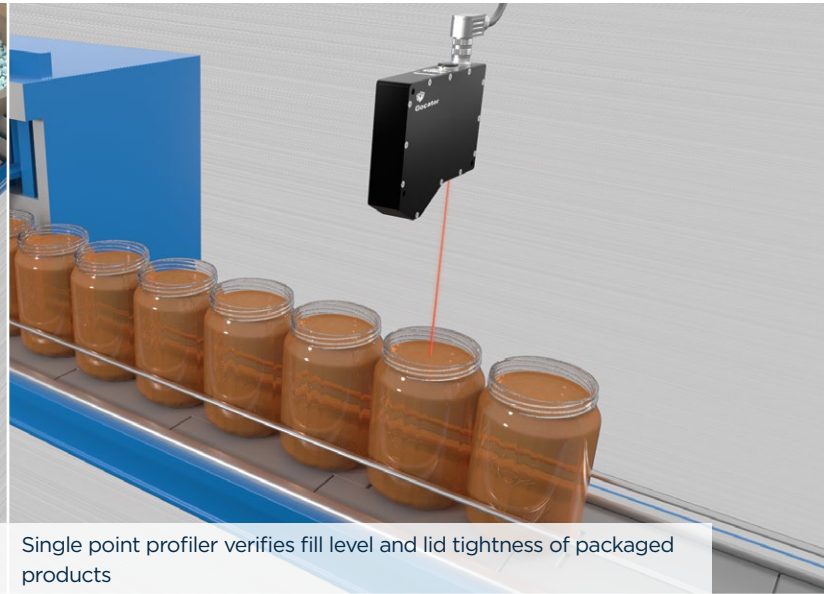

Single point profiler verifies fill level and lid tightness of packaged products

### Multi-Sensor Networking



**COMMON PROBLEM:**  
**TARGET IS LARGER THAN A SINGLE SENSOR CAN CAPTURE**



**FactorySmart® SOLUTION:**  
**EASY MULTI-SENSOR NETWORKING**

- » A Master Hub synchronizes multiple Gocator sensors and combines scans into a single high-density 3D point cloud of the entire surface or target object.
- » Built-in alignment and stitching makes working with multiple sensors easy.

# PRODUCT LINEUP

## LASER PROFILE SENSORS



### Gocator 1300 Series

High-speed (32 kHz) Point Profilers for Dimensional Measurements

- » Unique built-in part detection and profile generation
- » Ideal for closed loop control or measuring high speed processes



### Gocator 2100 Series

Low Cost, Entry-Level Line Profilers for Basic Inline 3D Inspection

- » Handles all of your basic quality inspection needs
- » VGA imager, 640 points per profile resolution
- » Field-of-view up to 1260 mm
- » Measurement range up to 800 mm



### Gocator 2300 Series

Workhorse Line Profilers for Robust Inline 3D Inspection

- » Handles a wide range of applications
- » Megapixel imager, 1280 points per profile resolution
- » Field-of-view up to 1260 mm
- » Measurement range up to 800 mm



### Gocator 2400 Series

Ultra High-Resolution Line Profilers for Advanced Inline 3D Inspection

- » Handles difficult targets such as micro-features on small parts in high-speed applications
- » 2-Megapixel imager, up to 1940 points per profile resolution
- » Field-of-view (FOV) up to 32 mm
- » Measurement range up to 25 mm



## Gocator 2880

Dual Triangulation Line Profilers for 3D Inspection of Large Objects

- » Two cameras maximize scan coverage and minimize occlusions for applications such as primary log scanning
- » Megapixel imager, 1280 points per profile resolution
- » Field-of-view up to 1260 mm
- » Measurement range up to 800 mm

## SNAPSHOT SENSORS



## Gocator 3506

Metrology-grade 12  $\mu\text{m}$  Sensor for Small Parts Inspection

- » Detect fine features on small parts such as electronic enclosures, PCB and battery/IC connectors
- » Fast scan rate (3 Hz full-field)
- » 5-megapixel stereo camera minimizes occlusions
- » High repeatability (2  $\mu\text{m}$ ) for reliable measurements at production speed

## Gocator 3210

Metrology-grade 35  $\mu\text{m}$  Sensor for Large Parts Inspection

- » Detect features on large objects such as automotive cylinders
- » Fast scan rate (4 Hz full-field)
- » 2-megapixel stereo camera minimizes occlusions
- » Wide field of view (FOV) up to 154 mm

# PRODUCT SPECS

Gocator 1300 Series		Point Profile					
MODELS	1320	1340	1350	1365	1370	1380	1390
Clearance Distance (mm)	40	162.5	200	562	237.5	127	500
Measurement Range (mm)	20	95	200	375	412.5	1651	2000
Linearity Z (+/- % of MR)	0.05	0.05	0.05	0.11	0.07	0.18	0.1
Linearity Z (+/- mm)	0.01	0.05	0.1	0.4	0.3	3.0	2.0
Resolution Z (mm)	0.0004 - 0.0004	0.0005 - 0.0010	0.0015 - 0.0035	0.0025 - 0.0040	0.0025 - 0.0070	0.0100 - 0.0450	0.0250 - 0.0600
Spot Size (mm)	0.11	0.37	0.50	1.80	0.90	2.60	2.60
Recommended Laser Class	3R	3B	3B	3B	3B	3B	3B
Other Laser Class	3B	2M, 3R			2M		
Recommended Package Dimensions (mm)	Side Mount (3R) 30x120x149	Side Mount 30x120x149	Side Mount 30x120x149	Side Mount 30x120x220	Side Mount (3B) 30x120x149	Side Mount 30x120x149	Side Mount 30x120x277
Other Package Dimensions (mm)	Top Mount (3B) 49x75x162		Top Mount 49x75x162		Top Mount (2M) 49x75x162		
Weight (kg)	0.75 / 0.8	0.75	0.75 / 0.8	1.0	0.75 / 0.8	0.75	1.25

Resolution Z based on averaging 128 samples. Optical models, laser classes, and packages can be customized. Contact LMI for more details. Specifications stated are based on standard laser classes. Resolution Z and Linearity Z may vary for other laser classes. Refer to specifications in the Gocator Point Profile Sensor user manual for more details.

## ALL 1300 SERIES MODELS

Scan Rate (Hz)	32,000
Interface	Gigabit Ethernet
Inputs	Differential Encoder, Laser Safety Enable, Trigger
Outputs	2x Digital Output, RS-485 Serial, Selcom Serial, 1x Analog Output (4-20mA)
Input Voltage (Power)	+24 to +48 VDC (13 Watts); Ripple +/- 10%
Housing	Gasketed aluminum enclosure, IP67
Operating Temperature	0 to 50 °C
Storage Temperature	-30 to 70 °C
Vibration Resistance	10 to 55 Hz, 1.5 mm double amplitude in X, Y and Z directions, 2 hours per direction
Shock Resistance	15 g, half sine wave, 11 ms, positive and negative for X, Y and Z directions
Scanning Software	Browser-based GUI and open source SDK for configuration and real-time 3D visualization. Open source SDK, native drivers, and industrial protocols for integration with user applications, third-party image processing applications, and PLCs.

Gocator 2100 Series		Line Profile			
MODELS	2130	2140	2150	2170	2180
Data Points / Profile	640	640	640	640	640
Linearity Z (+/- % of MR)	0.01	0.01	0.01	0.04	0.04
Resolution Z (mm)	0.006 - 0.014	0.013 - 0.037	0.019 - 0.060	0.055 - 0.200	0.092 - 0.488
Resolution X (mm) (Profile Data Interval)	0.088 - 0.150	0.19 - 0.34	0.3 - 0.6	0.55 - 1.10	0.75 - 2.20
Repeatability Z (µm)	0.8	1.2	2	8	12
Clearance Distance (CD) (mm)	90	190	300	400	350
Measurement Range (MR) (mm)	80	210	400	500	800
Field of View (FOV) (mm)	47 - 85	96 - 194	158 - 365	308 - 687	390 - 1260
Recommended Laser Class	2M	3R	3R	3B	3B
Other Laser Classes	-	2M	2M	3R	-
Dimensions (mm)	Top Mount 49x75x142	Top Mount 49x75x197	Top Mount 49x75x272	Top Mount 49x75x272	Top Mount 49x75x272
Weight (kg)	0.74	0.94	1.3	1.3	1.3

Optical models, laser classes, and packages can be customized. Contact LMI for more details. Specifications stated are based on standard laser classes. Linearity Z, Resolution Z, and Repeatability Z may vary for other laser classes. Refer to specifications in the Gocator Line Profile Sensor user manual for more details.

## ALL 2100 SERIES MODELS

Scan Rate	Approximately 170 Hz to 5000 Hz
Interface	Gigabit Ethernet
Inputs	Differential Encoder, Laser Safety Enable, Trigger
Outputs	2x Digital output, RS-485 Serial (115 kBaud), 1x Analog Output (4 - 20 mA)
Input Voltage (Power)	+24 to +48 VDC (13 Watts); Ripple +/- 10%
Housing	Gasketed aluminum enclosure, IP67
Operating Temperature	0 to 50°C
Storage Temperature	-30 to 70°C
Vibration Resistance	10 to 55 Hz, 1.5 mm double amplitude in X, Y and Z directions, 2 hours per direction
Shock Resistance	15 g, half sine wave, 11 ms, positive and negative for X, Y and Z directions
Scanning Software	Browser-based GUI and open source SDK for configuration and real-time 3D visualization. Open source SDK, native drivers, and industrial protocols for integration with user applications, third-party image processing applications, and PLCs.

## LASER PROFILE SENSORS

### Gocator 2300 Series

### Line Profile

MODELS	2320	2330	2340	2350	2370	2380
Data Points / Profile	1280	1280	1280	1280	1280	1280
Linearity Z (+/- % of MR)	0.01	0.01	0.01	0.01	0.04	0.04
Resolution Z (mm)	0.0018 - 0.0030	0.006 - 0.014	0.013 - 0.037	0.019 - 0.060	0.055 - 0.200	0.092 - 0.488
Resolution X (mm) (Profile Data Interval)	0.014 - 0.021	0.044 - 0.075	0.095 - 0.170	0.150 - 0.300	0.275 - 0.550	0.375 - 1.100
Repeatability Z (µm)	0.4	0.8	1.2	2	8	12
Clearance Distance (CD) (mm)	40	90	190	300	400	350
Measurement Range (MR) (mm)	25	80	210	400	500	800
Field of View (FOV) (mm)	18 - 26	47 - 85	96 - 194	158 - 365	308 - 687	390 - 1260
Recommended Laser Class	2M	2M	3R	3R	3B	3B
Other Laser Classes	3R	3R, 3B	2M, 3B	2M, 3B	3R	
Dimensions (mm)	Side Mount 35x120x149.5	Top Mount 49x75x142	Top Mount 49x75x197	Top Mount 49x75x272	Top Mount 49x75x272	Top Mount 49x75x272
Weight (kg)	0.8	0.74	0.94	1.3	1.3	1.3

Optical models, laser classes, and packages can be customized. Contact LMI for more details. Specifications stated are based on standard laser classes. Linearity Z, Resolution Z, and Repeatability Z may vary for other laser classes. Refer to specifications in the Gocator Line Profile Sensor user manual for more details.

#### ALL 2300 SERIES MODELS

Scan Rate	Approximately 170 Hz to 5000 Hz
Interface	Gigabit Ethernet
Inputs	Differential Encoder, Laser Safety Enable, Trigger
Outputs	2x Digital output, RS-485 Serial (115 kBaud), 1x Analog Output (4 - 20 mA)
Input Voltage (Power)	+24 to +48 VDC (13 Watts); Ripple +/- 10%
Housing	Gasketed aluminum enclosure, IP67
Operating Temperature	0 to 50°C
Storage Temperature	-30 to 70°C
Vibration Resistance	10 to 55 Hz, 1.5 mm double amplitude in X, Y and Z directions, 2 hours per direction
Shock Resistance	15 g, half sine wave, 11 ms, positive and negative for X, Y and Z directions
Scanning Software	Browser-based GUI and open source SDK for configuration and real-time 3D visualization. Open source SDK, native drivers, and industrial protocols for integration with user applications, third-party image processing applications, and PLCs.

### Gocator 2400 Series

### Line Profile

MODELS	2410	2420
Data Points / Profile	1710	1940
Linearity Z (+/- % of MR)	0.015	0.006
Resolution Z (µm)	1100	1.800 - 3.000
Resolution X (µm) (Profile Data Interval)	5.8 - 6.2	14.0 - 16.5
Repeatability Z (µm)	0.2	0.4
Clearance Distance (CD) (mm)	19.0	60.0
Measurement Range (MR) (mm)	6.0	25.0
Field of View (FOV) (mm)	10.0 - 10.0	27.0 - 32.0
Recommended Laser Class	3R (blue, 405 nm)	3R (blue, 405 nm)
Other Laser Classes	2M (blue, 405 nm)	2M (blue, 405 nm)
Dimensions (mm)	44x90x145	44x90x145
Weight (kg)	0.88	0.88

Optical models, laser classes, and packages can be customized. Contact LMI for more details. Specifications stated are based on Recommended laser classes. Linearity Z, Resolution Z, and Repeatability Z may vary for other laser classes.

#### ALL 2400 SERIES MODELS

Scan Rate	200 Hz (expanded full window), 400 Hz (G23xx equivalent full window), up to 5 kHz
Interface	Gigabit Ethernet
Inputs	Differential Encoder, Laser Safety Enable, Trigger
Outputs	2x Digital output, RS-485 Serial (115 kBaud), 1x Analog Output (4 - 20 mA)
Input Voltage (Power)	+24 to +48 VDC (9 Watts); Ripple +/- 10%
Housing	Gasketed aluminum enclosure, IP67
Operating Temperature	0 to 50°C
Storage Temperature	-30 to 70°C
Vibration Resistance	10 to 55 Hz, 1.5 mm double amplitude in X, Y and Z directions, 2 hours per direction
Shock Resistance	15 g, half sine wave, 11 ms, positive and negative for X, Y and Z directions
Scanning Software	Browser-based GUI and open source SDK for configuration and real-time 3D visualization. Open source SDK, native drivers, and industrial protocols for integration with user applications, third-party image processing applications, and PLCs.

# PRODUCT SPECS

Gocator 2800 Series		Line Profile
MODELS	2880	
Data Points / Profile	1280	
Linearity Z (+/- % of MR)	0.04	
Resolution Z (mm)	0.092 - 0.488	
Resolution X (mm) (Profile Data Interval)	0.375 - 1.100	
Clearance Distance (CD) (mm)	350	
Measurement Range (MR) (mm)	800	
Field of View (FOV) (mm)	390-1260	
Laser Class	3B (<500 mW)	
Dimensions (mm)	49x75x498	
Weight (kg)	2.56	
Scan Rate	380 Hz - 2500 Hz	
Interface	Gigabit Ethernet	
Inputs	Differential Encoder, Laser Safety Enable, Trigger	
Outputs	2x Digital output, RS-485 Serial (115 kbaud), 1x Analog Output (4 - 20 mA)	
Input Voltage (Power)	+24 to +48 VDC (13 Watts); Ripple +/- 10%	
Housing	Gasketed aluminum enclosure, IP67	
Operating Temperature	0 to 50°C	
Storage Temperature	-30 to 70°C	
Vibration Resistance	10 to 55 Hz, 1.5 mm double amplitude in X, Y and Z directions, 2 hours per direction	
Shock Resistance	15 g, half sine wave, 11 ms, positive and negative for X, Y and Z directions	
Scanning Software	Browser-based GUI and open source SDK for configuration and real-time 3D visualization. Open source SDK, native drivers, and industrial protocols for integration with user applications, third-party image processing applications, and PLCs.	

## SNAPSHOT SENSORS

Gocator 3000 Series		3210	3506
MODELS	3210		3506
Scan Rate (Hz)	4	3	
Imagers (megapixels)	2	5	
Clearance Distance (CD) (mm)	164.0	87.0	
Measurement Range (MR) (mm)	110.0	25.0	
Field of View (mm)	71.0 x 98.0 - 100.0 x 154.0	27.0 x 45.0 - 30.0 x 45.0	
Repeatability Z (µm)	4.7	2.0	
Resolution XY (mm)	0.060 (CE) - 0.090 (FE)	0.020 (CE) - 0.025 (FE)	
VDI/VDE Accuracy (mm)*	0.035	0.012	
Dimensions (mm)	49 x 146 x 190	49 x 136 x 170	
Weight (kg)	1.7	1.52	
Light Source	Blue LED (465 nm)	Blue LED (465 nm)	
Interface	Gigabit Ethernet	Gigabit Ethernet	
Inputs	Differential Encoder, Trigger	Differential Encoder, Trigger	
Outputs	2x Digital Output, RS485 Serial (115 kbaud), 1x Analog Output (4 - 20 mA)	2x Digital Output, RS485 Serial (115 kbaud), 1x Analog Output (4 - 20 mA)	
Input Voltage (Power)	+24 to +48 VDC (50 Watts); Ripple +/- 10%	+24 to +48 VDC (25 Watts); Ripple +/- 10%	
Housing	Gasketed aluminum enclosure, IP67	Gasketed aluminum enclosure, IP67	
Operating Temperature	0 to 45 °C	0 to 50 °C	
Storage Temperature	-30 to 70 °C	-30 to 70 °C	
Vibration Resistance	10 to 55 Hz, 1.5 mm double amplitude in X, Y and Z directions, 2 hours per direction	10 to 55 Hz, 1.5 mm double amplitude in X, Y and Z directions, 2 hours per direction	
Shock Resistance	15 g, half sine wave, 11 ms, positive and negative for X, Y and Z directions	15 g, half sine wave, 11 ms, positive and negative for X, Y and Z directions	
<b>SOFTWARE AND BUILT-IN 3D MEASUREMENT TOOLS</b>			
3D Feature Tools	Openings (holes, slots), Cylinders, Studs (threaded and non-threaded), Plane		
3D Volumetric Tools	Volumes, Areas, Bounding boxes, Positions (min, max, centroid), Ellipses, Orientations		
Scanning Software	Browser-based GUI and open source SDK for configuration and real-time 3D visualization. Open source SDK, native drivers, and industrial protocols for integration with user applications, third-party image processing applications, and PLCs.		

\* Based on 2634, Part 2

# SENSOR NETWORKING

Gocator laser profilers support seamless multi-sensor networking for scanning large or complex objects (i.e., with irregular surface geometry and multiple occlusions). These sensor networks are connected by LMI Master controllers.

## MASTER 810 & 2410

Master 810 and 2410 network controllers make it easy to distribute power, achieve microsecond data synchronization, and provide laser safety for up to 24 sensors per Master. Designed to scale, Masters provide uplink/download ports for daisy chaining, and support differential or single-ended encoder and digital I/O.

- » SYNCHRONIZED WITHIN 1  $\mu$ s ACCURACY
- » ALL-IN-ONE CABLING
- » BUILT-IN LASER SAFETY CONTROL

## BENEFITS OF MULTI-SENSOR SUPPORT

- » IDEAL FOR SCANNING LARGE OR COMPLEX TARGETS
- » SIMPLE POINT-AND-CLICK NETWORK SETUP
- » BUILT-IN LAYOUT ALIGNMENT AND STITCHING FOR MAXIMUM EASE OF USE
- » MAINTAINS HIGH RESOLUTION ACROSS WIDE FOV



Master 810. Supports up to 8 sensors.



Master 2410. Supports up to 24 sensors.

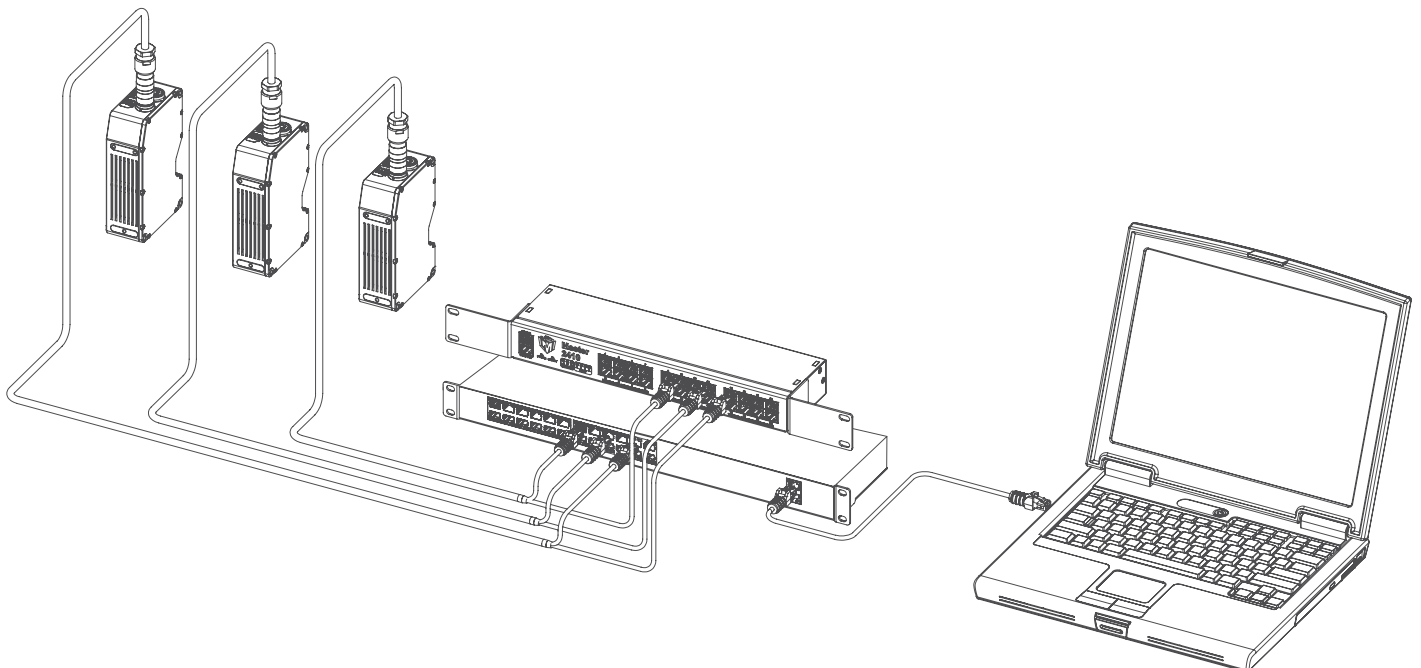

**It's Better to Be Smart.**

[contact@lmi3d.com](mailto:contact@lmi3d.com) | [lmi3d.com](http://lmi3d.com)

---

**AMERICAS**

LMI Technologies Inc.  
Burnaby, BC, Canada

**EMEAR**

LMI Technologies GmbH  
Teltow/Berlin, Germany

**ASIA PACIFIC**

LMI (Shanghai) Trading Co., Ltd.  
Shanghai, China



LMI Technologies has offices worldwide. All contact information is listed at [lmi3d.com/contact](http://lmi3d.com/contact)